

SERLUX



Solar Street Light

40W / 60W / 100W

Product Size:

SERLUX

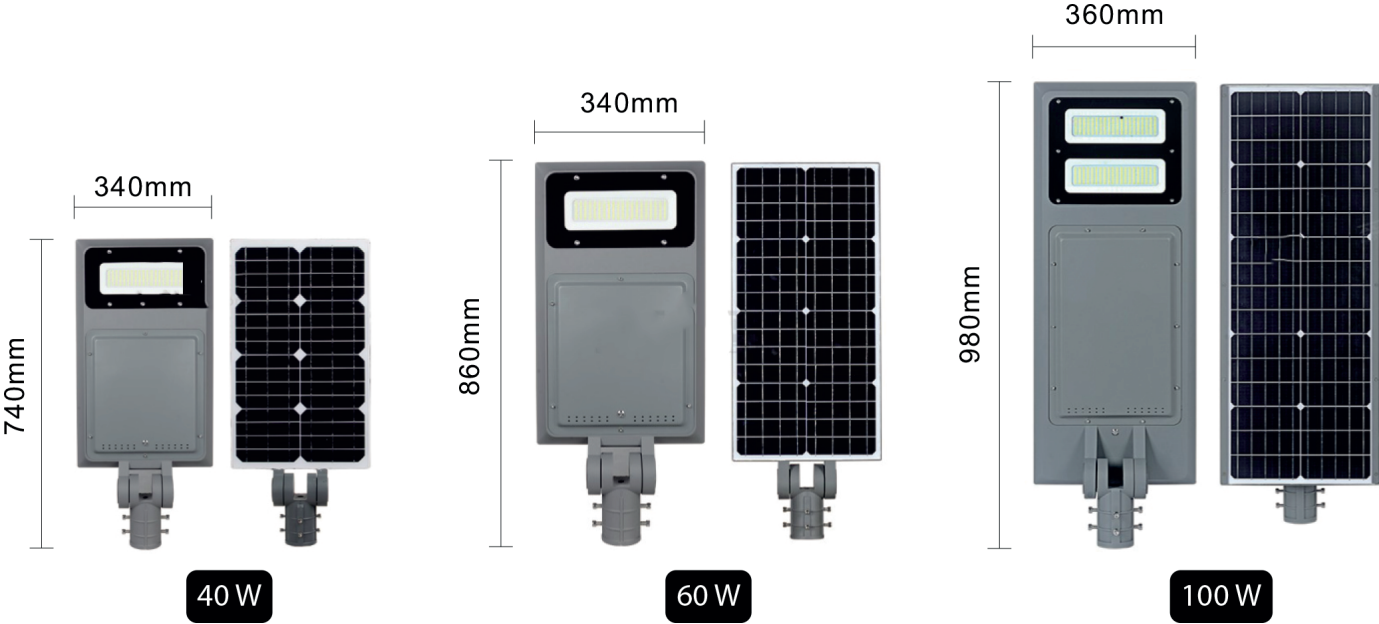

Product Details:

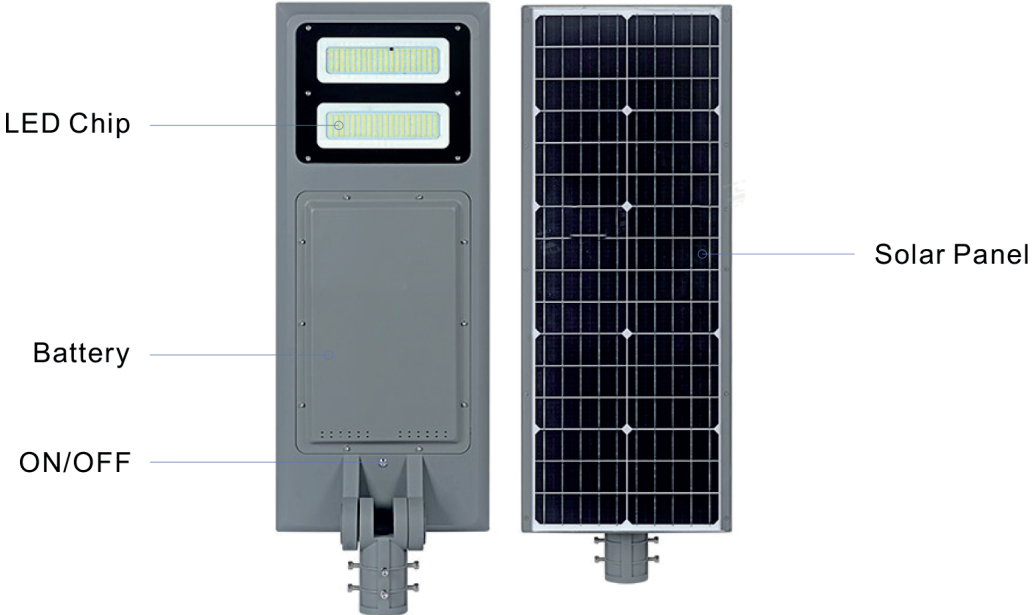

High quality

large capacity lithium battery

- Safe and reliable
- Light weight
- Long endurance
- Long battery life

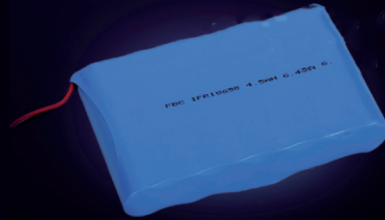

01

Adjustable Angle

Adjust angle for better solar charging and lighting.

02

Mono-Crystalline

Solar panel high efficiency near 20%



03

Ultra-bright

LED Chip 50000 hrs lifespan

Product Details:

SERLUX



04

Metal Switch
One button start



05

Bold Interface Line
IP65, effectively prevent the infiltration of rain.

LX-Distance Diagram:

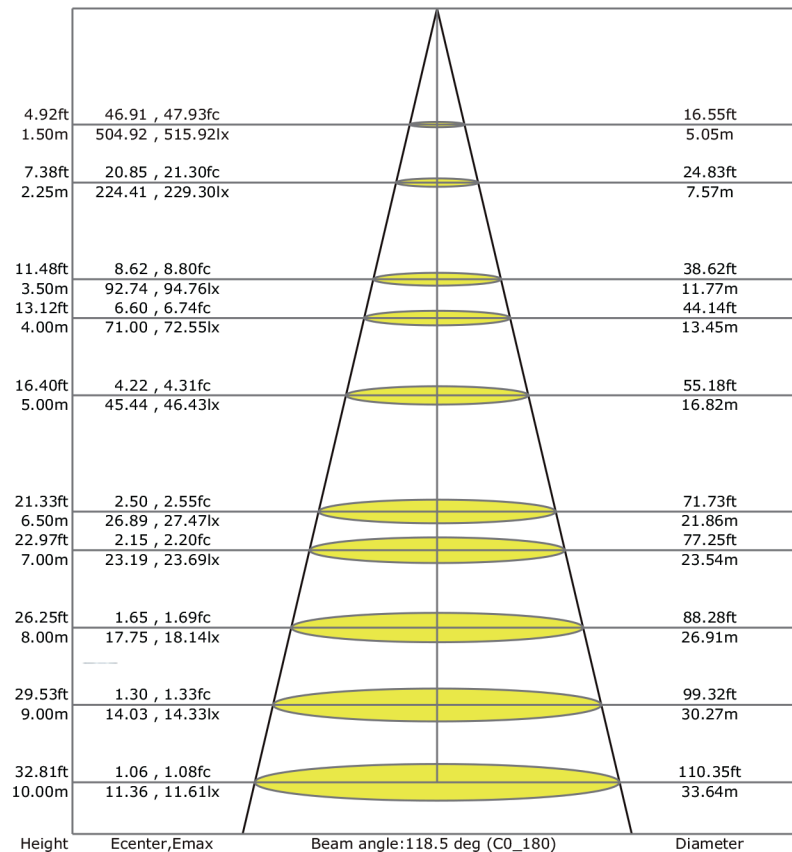
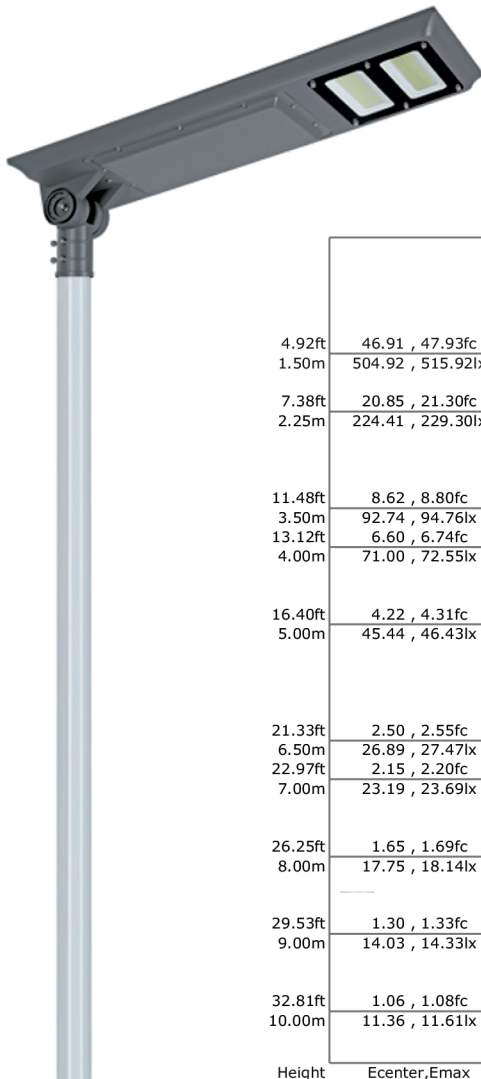

Lighting Data:

SERLUX

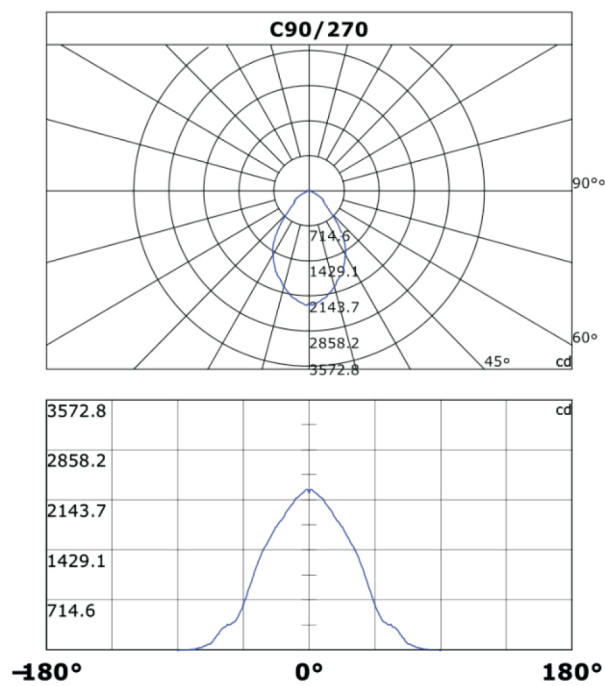
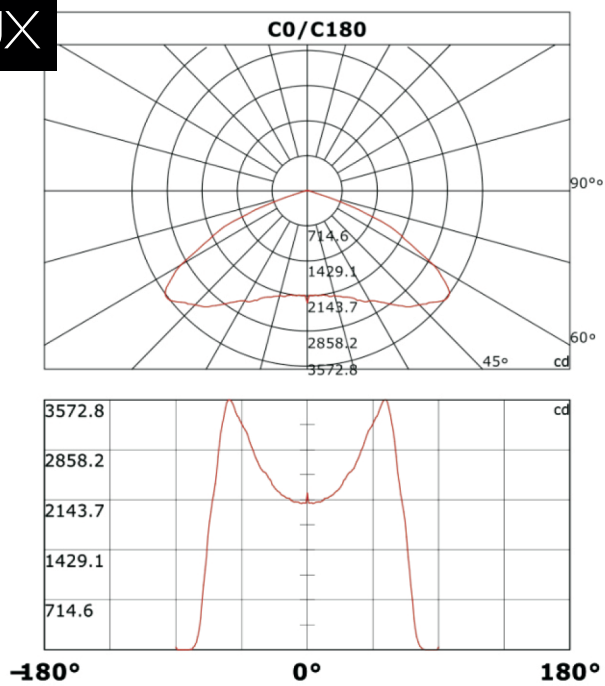

Installation Dimension:

Unit:mm

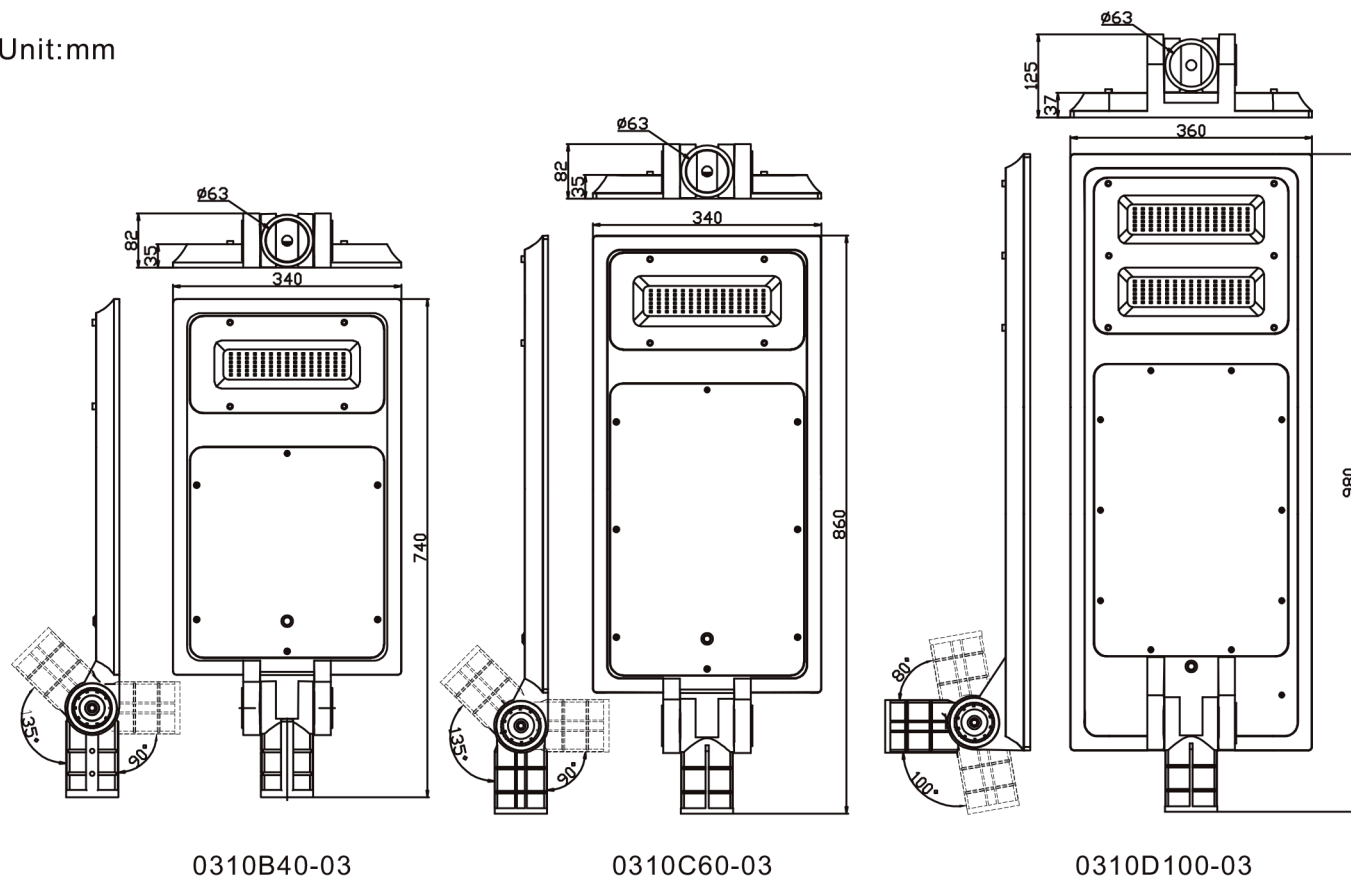

Production Workshop:



SERLUX

Applications:

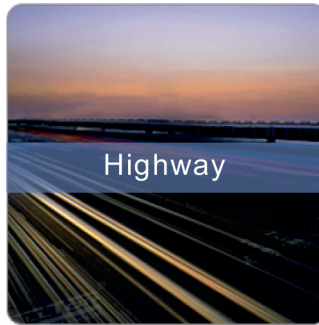
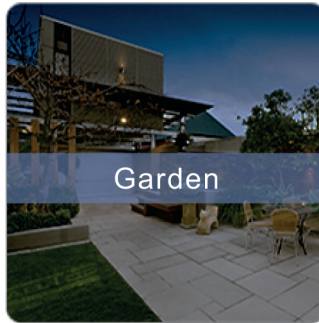
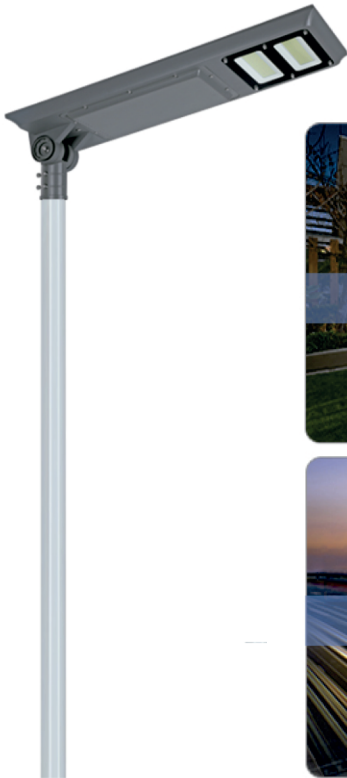

Certifications of Products:

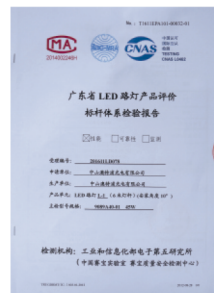

Product Specifications:

SERLUX



Product Parameter:

Model	0310B40-03	0310C60-03	0310D100-03
LED Lamp	5730LED 200PCS 3000K-6000K	5730LED 200PCS 3000K-6000K	5730LED 400PCS 3000K-6000K
Solar Panel	Mono-Crystalline 16V 38W	Mono-Crystalline 16V 48W	Mono-Crystalline 16V 64W
Battery Type	LiFePO4 12.8V 18AH	LiFePO4 12.8V 24AH	LiFePO4 12.8V 42AH
Charging Time	6-8 hours		
Discharging Time	30-36 hours		
Led	160lm/w		
Material	Die-Casting Aluminium		
Product Size	740*340*82mm	860*340*82mm	980*360*125mm
Install Height	4-7m	5-8m	6-9m
Warranty	3 years		

SERLUX

CARRASCO | CASA CENTRAL

Av. Italia 5672
2600 2028
092 792 893

PUNTA CARRETAS

Francisco Ros 2781
2711 7113
092 868 340

LAGOMAR

Av. Giannattasio KM 21.8
2698 5300
099 306 969

PUNTA DEL ESTE

Av. Italia esq. Patagonia
4249 5328
099 764 876